



## VIOMI Alpha 3 User Manual

Please read this manual carefully before use and keep it properly.  
This product shall be operated only in location at altitude below 2,000 meters.



## CONTENTS

VIOMI Alpha 3 User Manual .....	01
VIOMI Alpha 3 Bedienungsanleitung .....	25
Manuel d'Utilisateur de VIOMI Alpha 3 .....	49
Инструкция по эксплуатации VIOMI Alpha 3 .....	73
VIOMI Alpha 3 Instrukcja Użytkowania .....	97
Manual de usuario de VIOMI Alpha 3 .....	121
Manual do usuário do VIOMI Alpha 3 .....	145
VIOMI Alpha 3 Manuale Utente .....	169
VIOMI Alpha 3 Kullanım Kılavuzu .....	193

# 1. Instructions for use

Please pay attention to the following basic safety precautions before using the product:

- Read the user manual carefully and follow the instructions in the user manual when using the product.
- Keep the user manual well for future reference.
- If you need to transfer the product to a third party, please attach the user manual along with the product.
- Any operation not in conformity to the instructions in the user manual may result in serious personal injury or damage to the product itself.

 Warning: Instructions against incorrect product use that may lead to death or serious injury.

 Caution: Instructions against incorrect product use that may lead to minor injury or product damage.

 Read operator's manual

 This product should not be disposed of with normal waste. It must be recycled.

# 2. Safety precautions

 Warning

- This product can only use the cleaning station and batteries that are provided with this product. Failure to do so may result in damage to the product, electrical shock, or fire caused by high voltage.

- Do not use this product if the product and accessories of this product are found to be damaged. Contact our after-sales service department. Except for the service technicians designated or authorized by our company, no one may disassemble, repair or modify this product.
- Unplug the product before maintenance.
- Do not touch the power plug or the product when your hands are wet, as this may result in electrical shock.
- If the power cord is damaged, it must be replaced by the manufacturer, its service department or a similar professional to avoid danger.
- To prevent the product from falling accidentally, do not use this product in a suspended place without a protective fence, which may result in personal injury.
- The user shall not replace the batteries privately.
- Prevent clothing or any part of your body (hair, fingers, etc.) from getting caught in the brush or wheel of the vacuum cleaner. Failure to do so may result in personal injury.
- Do not place the product near fire or flammable/explosive/corrosive materials.
- If the user manual is missing, please contact your local dealer or call the after-sales service department to obtain an electronic user manual.
- If the supply cord is damaged, it must be replaced by the manufacturer, its service agent or similarly qualified persons in order to avoid a hazard.
- Please clean and maintain the main machine and cleaning station in the state of shutdown or power failure.

 Caution

- This appliance contains batteries that are only replaceable by skilled persons.
- For the purposes of recharging the battery, only use with the cleaning station provided with this appliance.

## Safety Information

- Check whether there are cigarette butts, matches and other inflammable and explosive items in the room. If there is one will need to manually clean up yourself before use of the product. Flammable items inhaled robot, the body in the use of the process will heat damage product.
- Clean side brushes and rollers regularly, clean the dust box regularly, clean the filter regularly.
- The appliance must be disconnected from the supply mains when removing the battery.
- The battery is to be disposed of safely.
- The product is only intended to clean floors in a home environment. Please do not use it outdoors such as on an open balcony or on a surface that is not a floor like a sofa, or in a commercial or industrial setting.
- Prevent the suction of water, oil or other liquids, which may damage the product.
- Please make sufficient preparations before starting the product to prevent the noise from causing harm to people or animals.
- Arrange scattered wires on the floor before use for fear of affecting the normal operation of the product.
- Remove fragile objects before use.
- The cleaning station shall be placed against the wall and on a flat floor for fear of affecting product functionality.
- Unplug the cleaning station if it remains unused for a long time.
- When the product is working, removal of the cleaning station will affect the normal recharging of the machine.
- Do not use the product to suck in sharp objects (e.g. shattered glass and nails) for fear of damage to the product.
- Do not use the product at an ambient temperature above 35°C or below 0°C or in a wet, flammable, explosive or corrosive environment.

- Do not pick up the product by its laser radar cover.
- Make sure the product is turned off and the cleaning station is unplugged before cleaning or performing maintenance.
- Do not place children, pets, or any item on top of the product while it is stationary or moving.
- Do not spray any liquid into the product (make sure the dust compartment is thoroughly dry before its reinstalling).
- Do not place the product upside down (laser radar housing should never touch the ground).
- Only use this product as directed in the user manual or quick start guide. Users are responsible for any loss or damage arising from improper use of this product.
- Please put away fragile objects and sundries (such as vases, plastic bags and mirrors, etc.) on the ground, so as to avoid damage to valuables at home when the main machine is blocked during operation or slightly collided.

## 3. About child safety



- Children shall not play with the product.
- Please keep the main brush cleaning tools out of reach of children.
- This product can be used by children aged from 8 years and above and persons with reduced physical, sensory or mental capabilities or lack of experience and knowledge if they have been given supervision or instruction concerning use of the appliance in a safe way and understand the hazards involved.
- Cleaning and user maintenance shall not be made by children without supervision.

### 4. About the batteries



- This product contains a lithium-ion battery pack.
- Do not expose the appliance or battery to excessive temperatures.
- Be aware of the risk of terminals of the battery-operated appliance or battery being short-circuited by metal objects.
- Before disposing of the appliance, the battery must be taken out of the appliance. Take-out steps:
  - A. Use a screwdriver to loosen the screws of the side brush and the base decorative plate.
  - B. Remove the base trim panel and side brush.
  - C. Take out the battery and unplug the connection line between the battery and the host.
- The batteries shall be removed when the product is discarded.
- If you need to replace the battery of the host machine, please contact our after-sales service department. Use of wrong batteries may cause a safety accident.
- If the batteries leak, prevent the contact of the liquid with the skin or clothing. Immediately wipe it with a dry cloth and send it to the recycling station or designated maintenance point. Do not discard it.
- Please properly dispose of the old batteries of the product. The batteries contain hazardous substances harmful to the environment. Please follow the local environmental regulations and send them to the designated recycling site.
- Charge the lithium battery robot vacuum cleaner, lithium battery, maximum capacity 5200mAh, voltage 14.4 Vdc.
- Cannot charge non-rechargeable batteries.

### 5. Scope of use of the product

The product is suitable for the following floors:  
Wooden floor, Ceramic tile and Short-staple carpet.

### 6. Disclaimers

Under any of the following circumstances, the product will be excluded from the scope of free warranty, but paid repair can be provided:

- A. Damage due to the user's failure to operate the product in strict accordance with our user manual or due to improper storage;
- B. The machine or parts have exceeded the free warranty period;
- C. Damage due to disassembly by those other than the maintenance personnel of our company or authorized by our company;
- D. A valid purchase voucher number cannot be provided;
- E. Damage caused by irresistible factors such as natural disasters;
- F. Product failure or damage caused by unexpected factors or man-made causes (including operational errors, liquid ingress, improper plugging/unplugging, scratching, handling, bumping, input of inappropriate voltage, etc.)

# Product Introduction

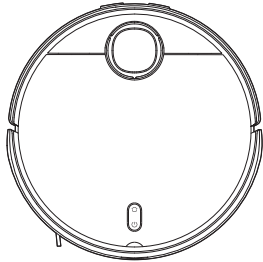

Main machine

## Accessories already installed on the main machine:

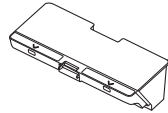

Dust box

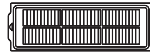

Filter screen  
(Installed on the dust box)



Main brush

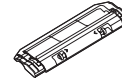

Main brush cover



Mop



Side brush

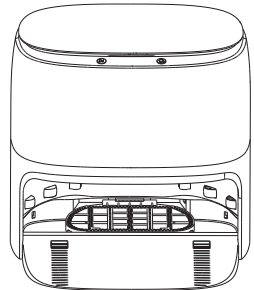

Cleaning station

## Accessories already installed on the cleaning station:

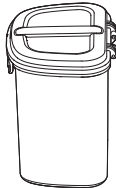

Fresh water tank



Dirty water tank



Sewage mesh

## Other accessories:

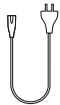

Power line



Side brush  
(for replacement)



Mop  
(for replacement)



Cleaning tool

Note: Illustrations of product, accessories, and user interface in the user manual are for reference purposes only. Actual product and functions may vary due to product enhancements.

Lore  
m  
ipsu  
m  
dolor  
sit  
amet,  
cons  
ec

# Product Introduction

## Main machine

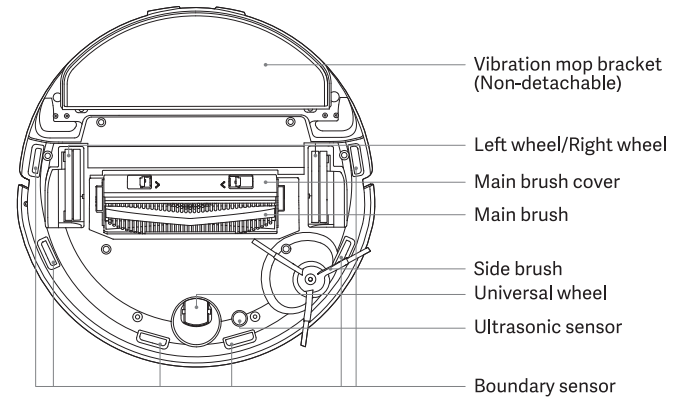
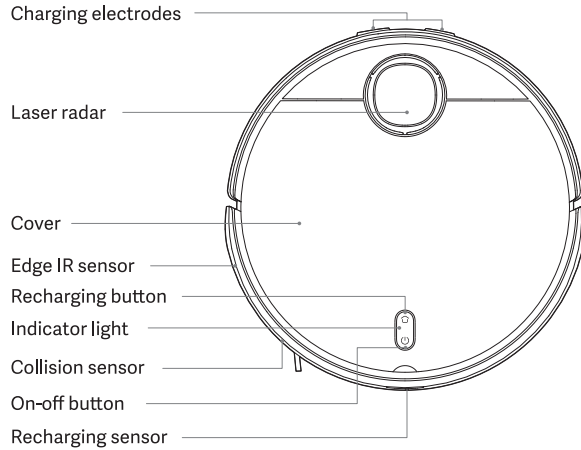



## Product Introduction

### On-off button

Press for 3s, power-on or power-off

Press for a short period of time, cleaning or pausing

### Recharging button

In operating, short press, main machine paused

In pausing, short press, start recharge

In the recharge, short press, stop recharge

### Instructions to the indicator light status of the main machine

White light is always on	The main machine is normal	Yellow light is always on	Main machine Wi-Fi is offline
White light breathes	In charging	Yellow light flashes	The main machine is abnormal
White light flashes	In recharging / firmware upgrading	The light of main machine is off	Off/sleepy

### Instructions to the indicator light status of the cleaning station

White light is always on	Cleaning station is normal
White light flashes	In cleaning
Yellow light flashes	Cleaning station is abnormal

# Product Introduction

## Main machine

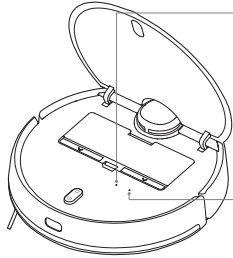

- Wi-Fi indicator light  
Blue light stays on for 2s and then goes out: Wi-Fi is connected  
Blue light flashes: Wi-Fi connection in progress / firmware upgrade in progress  
Yellow light flashes: Wi-Fi waits for connection
- Reset button  
Press for 3s, reset the system  
Press for 10s, recover the system

## Dust box

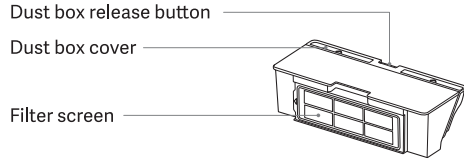

**Note:** Dust boxes should be installed in both the cleaning mode and the sweeping and mopping mode, otherwise the main machine can't be started.

## Vibration mop bracket

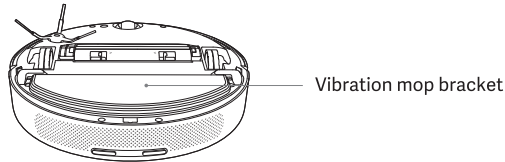

## Cleaning station (near the wall)

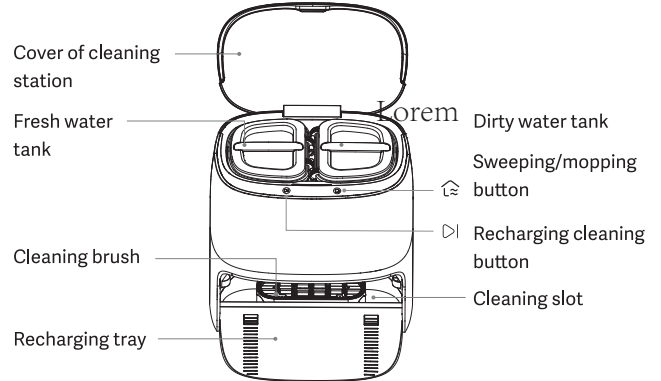
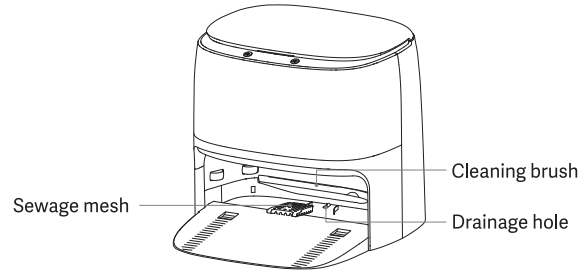

## Installation

Place the cleaning station against the wall and connect the power line

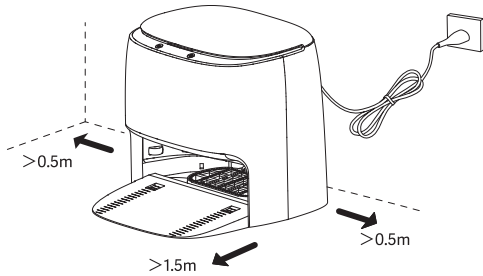

### Tips:

- Do not expose the cleaning station to direct sunlight.
- Please ensure a space of at least 0.5m on both the left and right sides of the cleaning station, and a space of at least 1.5m in front of it.
- Pay attention to the power line, otherwise it may be dragged by the robot, causing the cleaning station to move or power off.
- The fresh water tank, dirty water tank, and sewage mesh must be installed in place.

## Power on and charging

When using for the first time, please move the main machine to the charging pole piece and align it with the charging shrapnel of the cleaning station to charge.

In daily use, directly press the "🏠" button to start intelligent recharging.

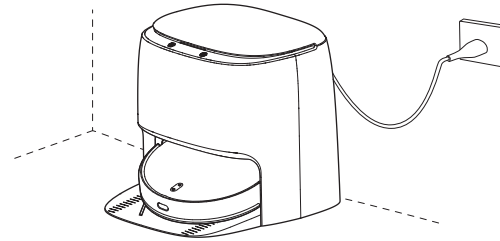

## Remove anti-collision protection strip

Before use, be sure to remove the anti-collision protection strips on both sides of the main machine.

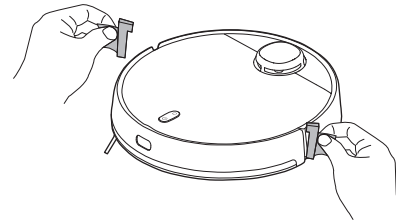

## Installation

### ▷ Sweeping/mopping button:

- In stand-by, press for a short period of time, start cleaning
- In cleaning, press for a short period of time, pause cleaning
- In recharging, press for a short period of time, stop recharging

### ⌂ Recharging cleaning button:

- In in-station stand-by, press for a short period of time, start cleaning
- In in-station cleaning, press for a short period of time, stop cleaning
- Outside-station, press for a short period of time, recharge
- In in-station stand-by, press for a long period of time, start air drying
- In in-station air drying, press for a long period of time, stop air drying

### Tips:

- For the first time of charging, please use it after fully charging to protect the battery.
- When main machine fails to power on due to low battery level, place it on cleaning station for charging.
- The main machine will start up automatically after connected to the cleaning station, and cannot be shut down during charging.

## Install accessories based on the demanded cleaning mode:

### Sweeping mode (install dust box):

Open the face cover from the opening, put the dust box into the main machine and make sure that the buckle is fastened securely.

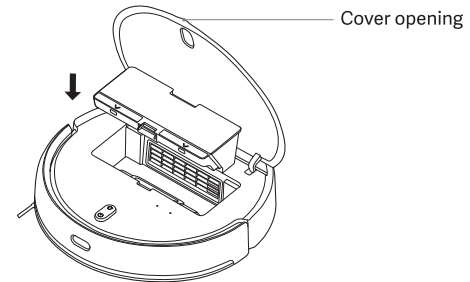

Tips: Clean the dust box regularly to avoid the dirt affecting the cleaning effect.

# Installation

Mopping mode (installation of fresh water tank and dirty water tank and mop):

1. According to the figure, insert the mop along the slot of the vibrating mop support and stick it on the hook & loop.

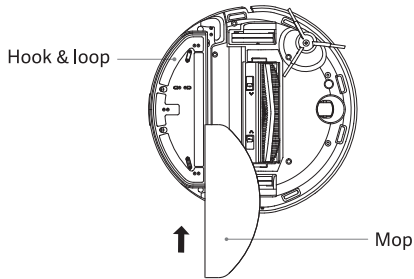

2. Take out the fresh water tank and add municipal tap water below the maximum water level.

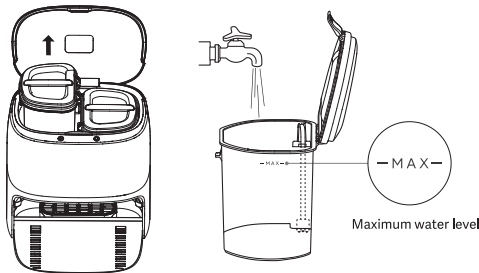

**Tip:** Please check the dirty water tank regularly. If there is dirty water, please dump it in time to ensure that there is no water in the dirty water tank.

3. Install the fresh water tank and dirty water tank into the cleaning station, and fasten the cover of the cleaning station after completion.

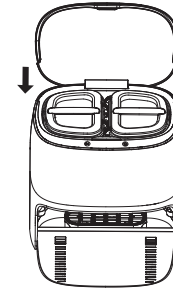

## Notices:

- In order to ensure the sterilization effect of brine electrolysis, please add municipal tap water into the fresh water tank and do not use purified water.
- Do not inject hot water into the fresh water tank to avoid deformation of the fresh water tank.
- Do not inject hot water into the dirty water tank to avoid deformation of the dirty water tank.
- When mopping the floor, please set up virtual walls or forbidden zones in the carpet area.
- It is forbidden to use cleaning products such as detergent, disinfectant and solid detergent to avoid corrosion and damage to the equipment.
- In case of water accumulation, please clean up the accumulated water before using the function of cleaning or mopping.
- After mopping the floor, please take out and clean the dirty water in time, and clean the cleaning brush, cleaning slot and sewage mesh to avoid odor and mildew

## How to connect to Wi-Fi

### Connect power supply

Connect power plug to the socket.

### Download the App

Search for "Mi Home" in app store; or scan the QR code to download and install the app.

### Connect to Mi Home App

This product works with Mi Home app. Control your device, and interact it and other smart home devices with Mi Home app.

Notes: As Mi Home App is subject to improvement and update from time to time, the actual operations may vary from what is described above. Please perform your operations by following the instructions in current Mi Home App.

Attention: "works with Mijia" validates in software level only. MIUI and Mi Home is not responsible for the enterprise and its production, standard implementation, quality supervision and other aspects of the product.



Scan the QR code to download and install the app. You will be directed to the connection setup page if the app is installed already. Or search "Mi Home" in the app Store to download and install it. Open the app, tap "+" on the upper right, and then follow prompts to add your device.



### Configure the network

Press and hold the "⏻ + 🏠" buttons for 7s to configure the network

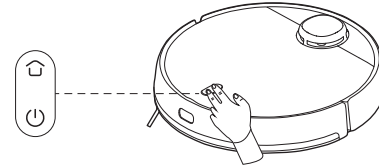

### Bind Android-based cell phone to Wi-Fi

Tap the available product, and tap "connect" to proceed. Just follow the tips.

### Bind iOS-based cell phone to Wi-Fi

Select robot's hotspot in Wi-Fi settings of your phone, and wait for connection; Return to the App, tap "next" and follow the tips to finish connection.

Notes: Please refer to How to Reset Wi-Fi when your phone is unable to connect Viomi vacuum (as following); Please connect to Wi-Fi for optimal user experience.

### Resetting Wi-Fi

When your router is replaced or Wi-Fi password is changed, you have to reset Wi-Fi settings by holding both ⏻ and 🏠 keys for 7 seconds till the Wi-Fi indicator light flashes in blue color and a voice prompt is given, indicating that the Wi-Fi settings are reset successfully.

## Operation

### Power-On/Off

Press “⏻” of the main machine for 3s, indicator light is on and the main machine is on.

When the main machine is not charged and paused, press “⏻” for 3s to make it power-off.

### Memory map

In the APP, the main machine will automatically save the updated map after quick mapping or completing cleaning and successful recharging. After a map is completed successfully, you can split or merge zones or name any room in the App.

### Cleaning

In the power-on state, press the “⏻” button for a short period of time, and the main machine starts to work.

### Vibration mopping mode

Vibration mopping mode is adopted by default when mopping the floor, which can enhance mopping effect. The mode can be turned off in the APP.

### Model/level selection

In the APP, a variety of cleaning modes and suction gears can be selected.

### Pause

When the main machine is running, press the “⏻” button of the main machine for a short period of time to stop cleaning, and then press the “⏻” button for a short period of time again to continue cleaning.

### Equipment recharge

When the main machine completes cleaning, it will automatically recharge, and determine whether to clean the mop according to the cleaning mode; The main machine is outside of the station, press the “⏻” button of the main machine for a short period of time to start recharging. After recharging successfully, judge whether to clean the mop according to the cleaning mode.

### Water adding or pouring in water tank

Please fill the fresh water tank with clean water before the sweeping and mopping robot works.

Please pour out the water in the dirty water tank and clean it up after the sweeping and mopping robot works.

**Tip:** It is forbidden to use cleaning products such as detergent, disinfectant and solid detergent to avoid corrosion and damage to the equipment.

## Operation

### Mop cleaning

In the process of sweeping and mopping, the main machine will automatically return to the cleaning station to clean the mop midway; after cleaning is completed, the main machine will automatically return to the interruption point to continue sweeping and mopping;

In the process of sweeping and mopping, press the “” button of the cleaning station for a short period of time, and the main machine will return to the cleaning station and clean the mop;

After sweeping and mopping, the main machine will automatically return to the cleaning station to clean the mop; after cleaning, enter the stand-by state;

In the process of sweeping and mopping, press the “” button of the main machine for a short period of time, and the main machine will start recharging and automatically clean the mop, and then enter the stand-by state after cleaning;

In stand-by state in the cleaning station, press the “” button of the cleaning station for a short period of time to clean the mop. After cleaning, it will enter the stand-by state.

### Scheduled cleaning

User can schedule a cleaning task in App, and main machine will start the cleaning task as scheduled and return to cleaning station upon end of the task.

**Tips:** Any scheduled cleaning task will not be executed during the time when non-disturbance mode is activated.

### Breakpoint Resume

This product has the function of breakpoint resume. During the cleaning process, when the power is low, the main machine will automatically find the cleaning station to charge, and after charging, it will return to the breakpoint to continue cleaning. If the cleaning is manually finished or the main machine is moved or operated during recharging or charging, this breakpoint resume will be canceled.

### Virtual Wall/ Restricted Area

User can define virtual wall/ restricted area in APP which main machine will avoid cleaning.

Tips:

- Before using this function, you have to store a map in the App.
- Moving the main machine or change of indoor environment may cause the original map lost and any virtual wall/ restricted area unavailable.

### Global cleaning

When no map is stored, if global cleaning is choose, the main machine will start cleaning each zone by a square area of 6m×6m. When any map is stored, if global cleaning is choose, the main machine will start cleaning each room along the planned route. Upon completion of cleaning, the main machine will return to cleaning station.

### Edge Cleaning

When choosing edge cleaning in the App, the main machine will automatically recognize range of the area to clean, and start cleaning along edge, and return to cleaning station automatically after finishing cleaning.



## Operation

### Specified-area cleaning

When an area to be cleaned is defined in APP, the main machine will clean the defined area.

**Tips:** During cleaning, the main machine may go beyond a defined area, so be sure to remove any obstacle on the floor within defined area since definition of any area will not ensure safe separation.

### Fixed-point cleaning

When choosing fixed-point cleaning and choose a target point in APP, the main machine will route cleaning task and start cleaning within a rectangular area of 2m × 2m based on the target position defined in the map in App.

### Non-Disturbance Mode

When non-disturbance mode is activated, proceeding at breakout point, scheduled cleaning and active voice reporting are unavailable for the main machine. Non-disturbance mode is activated by default during the period from 23:00 to 9:00. Non-disturbance mode can be deactivated in APP.

“During non-disturbance time period, the indicator light turns off after the main machine is charged for 1 minute.”

### Carpet identification

After the carpet is identified in the cleaning process of the sweeping and mopping robot, the suction enhancement will be automatically turned on and the mop is lifted, and this function can be turned off by using APP; or turn on the carpet avoidance function in the APP, and the sweeping and mopping robot will automatically bypass the carpet for cleaning.

**Tip:** For children's floor mats, yoga mats, sponge mats and hard short-haired carpets, there may be misjudgments, which will not affect the normal use. Virtual walls/forbidden zones can be set to prohibit the main machine from entering areas that do not need cleaning.

### Sleep

Unless during charging, the main machine will go to sleep automatically when it is left idle for 5 minutes; it will be powered off automatically when it has slept for 6 hours without appointment. In sleep status, press any button or APP will wake main machine up.

**Tips:** Main machine will not go to sleep on the cleaning station.

### Reset Wi-Fi

When your router or Wi-Fi access password has been changed, you have to reset your Wi-Fi connection by pressing and holding both "⏻" and "⏮" for 7 seconds when this product is power-on, and Wi-Fi connection is reset successfully when a voice prompt "Wi-Fi reset and network configuration activated" is given.

**Tips:** Only Wi-Fi network in 2.4GHz frequency is available to this product.

### Reset/Recover system

Press the reset button for 3s with a needle, and when you hear “successfully reset the system”, the main machine will restart automatically, and relevant settings such as scheduled cleaning and Wi-Fi will be recovered to the factory state.

Press the reset button for 10s with a needle, and when you hear “successfully recover the system”, the main machine will restart automatically, and the relevant settings such as scheduled cleaning and Wi-Fi will be recovered to the factory state, and the system will be recovered to the previous firmware version.

**Tips:** After resetting/recovering the system, the main machine needs to reconnect the APP, and the relevant settings in the APP are cleared.

## Product Maintenance

### Dustbin

1. Open the main machine cover, press the dust box release button, and take out the dust box.

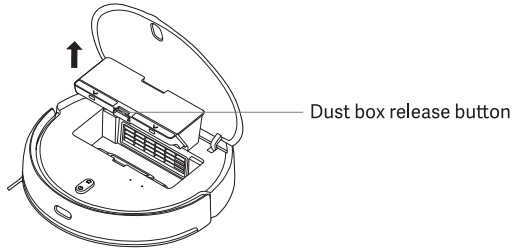

2. Open the dust box cover as shown in the figure, and dump the garbage.

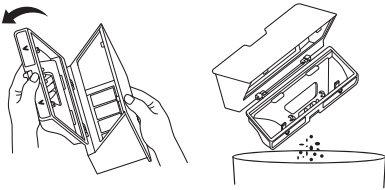

3. Take out the filter screen as shown in the figure, clean the dust box and filter screen with a cleaning tool, clean it with clear water, dry it and put it back in.

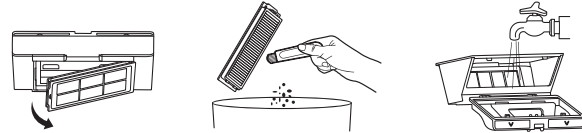

**Tips:** It is recommended to thoroughly clean the dust box at least once a week. Please dry the dust box and filter screen before use.

## Product Maintenance

### Dirty water tank/Sewage mesh

Take out the dirty water tank and dump the dirty water; lift up the cleaning brush and take out the sewage mesh for cleaning.

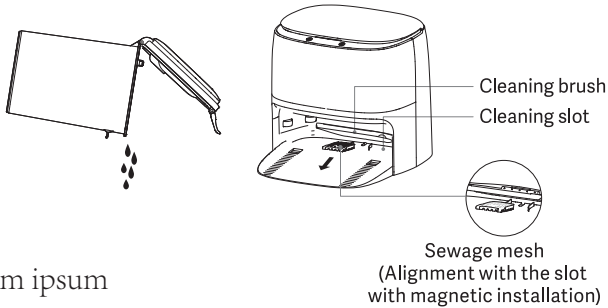

Lorem ipsum

#### Tips:

1. After mopping the floor, please take out and clean the dirty water tank in time, and clean the cleaning brush, cleaning slot and sewage mesh to avoid odor and mildew.
2. Clean the sewage mesh regularly to prevent hair and dirt from blocking the drainage hole.

### Main Brush

1. Turn over the main machine and press the two release buttons to remove the main brush cover.
2. Take out the main brush upward.
3. Pull out the main brush axle sleeve outward.
4. Rotate the main brush bracket so that the alignment identification on the main brush bracket is aligned with the unlocking identification and remove the main brush brackets at both ends of the main brush.
5. Cut the hair wound on the main brush with a knife on the cleaning tool and clean the main brush.
6. Install main brush bracket and main brush axle sleeve back.
7. Replace the main brush and main brush cover, and press the main brush cover to install it in place.

## Product Maintenance

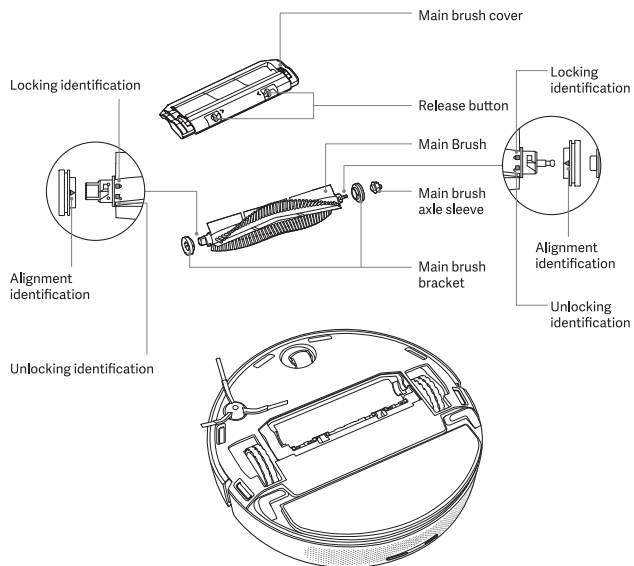

### Cleaning method of main brush

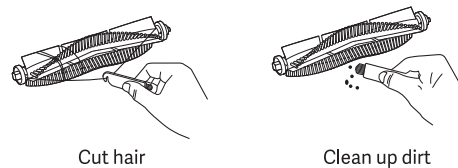

**Tips:** It is recommended to replace the main brush every 6-12 months to ensure the cleaning effect.

### Side brush

1. Turn over the main machine and remove the side brush fixing screw.
2. Remove and clean the side brush.
3. Replace the side brush and lock the screws.

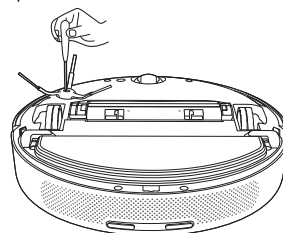

**Tips:** It is recommended to replace the side brush every 3-6 months to ensure the cleaning effect.

## Product Maintenance

### Universal wheel

1. Turn over the main machine and pull out the universal wheel upwards.
2. Clean the hair and dirt on the universal wheel.
3. Reinstall the universal wheel.

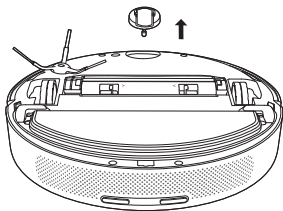

### Filter pipe of fresh water tank

1. Pull out the filter pipe in the fresh water tank.
2. Open the filter cover and clean the filter cover and sponge net.
3. Install the filter pipe back.

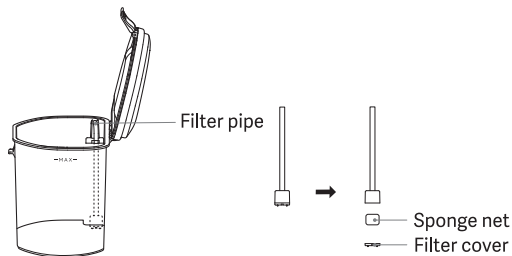

### Sensor

Please use soft dry cloth to clean boundary sensor and edge IR sensor regularly.

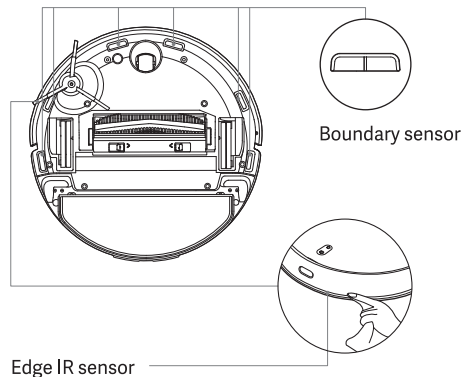

Tips: Do not use chemicals such as detergent or spray to clean the sensor.

## Instructions for use of micro-power equipment

1. The RF 433 MHz technology used in this product meets the technical requirements of universal wireless remote control equipment in the “catalogue and technical requirements of micro-power short-range radio transmitting equipment”, and is used for data transmission applications. Please refer to the related contents in the instruction manual for external PCB antenna, control, adjustment and switch, etc.
2. It is not allowed to change the use scene or conditions, expand the transmission frequency range and increase the transmission power (including additional RF power amplifier), and it is not allowed to change the transmission antenna without authorization.
3. It is not allowed to generate harmful interference to other legitimate radios (stations) or propose protection against harmful interference.
4. It shall bear the interference of industrial, scientific and medical (ISM) application equipment that radiates RF energy or other legitimate radios (stations).
5. If there is harmful interference to other legitimate radios (stations), it is needed to immediately stop using it and take measures to eliminate the interference before continuing to use.
6. The use of micro-power equipment in aircraft and electromagnetic environment protection areas such as radio observatories, weather radar stations, satellite earth stations (including observation and control, ranging, receiving and navigation stations) and other civil radios (stations) and airports designed according to laws and regulations, relevant state regulations and standards shall comply with the regulations of electromagnetic environment protection and relevant industry authorities.
7. It is forbidden to use all kinds of model remote controllers in the area with the center of the airport runway as the center and a radius of 5000m.
8. The working temperature of micro-power equipment in use is 0°C to 35 °C, and the rated working voltage of sweeping and mopping robot is 14.4V; the working voltage of cleaning station is 100-240V.

## Common Problems

Problem	Solution
Unable to power on	The battery is low. Please charge it before using.
Robot fails to start sweeping	The battery is low. Please charge it before using.
Robot cannot return for charging.	Too many barriers around cleaning station. Place cleaning station in an unblocked area. Robot is too far from cleaning station. Place robot near cleaning station and try again.
Abnormal robot actions	Please shut down and restart the robot.
Abnormal sound during cleaning	Please check and clean the foreign matters on the main brush, side brush, left/right wheel after the machine is turned OFF.
Cleaning performance deteriorates or dust drops.	Dust collector is full. Please empty the collector. Filter screen is blocked. Please clean the filter screen. Robot is blocked by any foreign object. Please clean the main brush.
Robot is offline	Weak Wi-Fi signals. Make sure robot is in proper coverage of Wi-Fi signals. Wi-Fi connection fails. Reset Wi-Fi connection and download the latest App and try again.
Robot fails to proceed at breakout point	Make sure non-disturbance mode is not activated, which will disable proceeding at breakout point. Breakpoint resume shall not be applicable for operating the main machine recharging button, operating the cleaning station sweeping and mopping function button, operating the APP recharging button or transporting the main machine back to the cleaning station.
Unable to charge	Make sure there is sufficient spaces around cleaning station, and there is no dust or blockage on the surface of electrode of cleaning station. The ambient temperature is too low (below 0°C) or too high (above 35°C).

## Common Problems

Problem	Solution
Fail to do scheduled cleaning	<p>If the equipment is not connected to the network, the time cannot be synchronized, and the scheduled cleaning shall not start.</p> <p>Make sure the main machine is not under non-disturbance mode, otherwise the scheduled cleaning is deactivated.</p>
Robot is always offline	<p>Please ensure that the robot network configuration is successful and that the robot is always within the coverage of Wi-Fi signal.</p>
Robot fails to connect to APP	<p>Ensure that the robot and the cleaning station are in the area with good Wi-Fi signal; reset Wi-Fi according to the steps described in the Instruction Manual; then pair again.</p>
Failure to clean mop	<p>The fresh water tank is short of water and please fill it with clean water. The dirty water tank is full, please pour out the dirty water and clean it up.</p> <p>The cleaning slot is full, please clean the drainage hole of the cleaning slot.</p>



## Troubleshooting

Fault Message	Solution
Make sure the laser ranging sensor is not blocked	Laser ranging sensor is blocked or jammed by foreign object. Remove the blockage or foreign object. If removal is impossible, relocate robot and then start it.
Clean boundary sensor and relocate robot	Robot is off ground. Relocate and restart robot. Boundary sensor is dirty. Clean the sensor.
Check collision sensor and remove any foreign object on it	Collision sensor is jammed. Remove foreign object by tapping the sensor. If there is no foreign object, relocate and restart robot.
Place robot on a horizontal ground and start it	It is detected that robot stays inclined. Place robot on a horizontal ground and start it, or perform leveling in App and then restart robot.
Put the main machine on the ground to start	The wheel is suspended. Please move to the new position to start.
Remove any obstacle around robot and try again	Robot may be jammed or trapped. Remove any barrier around it.
Make sure that the dust collector is mounted in place	Replace the dust box and filter screen, and make sure that the filter screen and dust box are installed in place.

Fault Message	Solution
Make sure the fresh water tank has been installed	Lösung Please install the fresh water tank back and make sure that it is in place.
Please make sure the dirty water tank has been installed	Please install the dirty water tank back and make sure that it is in place.
Please make sure the sewage mesh has been installed	Please clean the sewage mesh and make sure that the sewage mesh is installed in place.
The fresh water tank is empty. Please add clean water in time	Please check and supplement the fresh water tank.
The dirty water tank is full. Please clean it up in time	Please pour out the water in the dirty water tank and clean it up in time.
The cleaning slot is full. Please clean it up in time	Please check and clean the cleaning slot.
Please move the main machine back to the cleaning station	The main machine can't sense the position of the cleaning station. Please put the main machine back to the cleaning station for charging.
Low battery level. Please charge robot.	The power is too low, the main machine cannot start normally.

# Specifications

## Main machine

Model	V-RVCLMC28A
Size	353×353×96.5mm
Rated Power	40W
Rated Voltage	14.4V===
Charging Voltage	20V===
Battery capacity	5200mAh
Net weight	4.1kg
Wireless Connection	Wi-Fi IEEE 802.11b/g/n 2.4GHz Bluetooth 4.2 RF 433MHz

## Cleaning station

Model	V-RVCLMC28A
Rated input	100-240V~ 50/60Hz
Rated output	20V === 1.5A
Size of cleaning station	410×450×390mm
Wireless Connection	RF 433MHz

This product is in compliance with Class I laser safety standard under IEC60825-1:2014, and will not generate laser radiation hazardous to human.